

Recall

Principles of Feedback

Topics to be covered include:

- y An industrial motivational example;
- y A statement of the fundamental nature of the control problem;
- y Evolution from open loop inversion to closed loop feedback solutions.

08/04/2008

1/20

We will see that feedback is a key tool that can be used to modify the behaviour of a system.

This behaviour altering effect of feedback is a key mechanism that control engineers exploit deliberately to achieve the objective of acting on a system to ensure that the desired performance specifications are achieved.

08/04/2008

2/20

A motivating industrial example

We first present a simplified, yet essentially authentic, example of an industrial control problem. The example, taken from the steel industry, is of a particular nature, however the principal elements of specifying a desired behaviour, modelling and the necessity for trade-off decisions are generic.

08/04/2008

3/20

Photograph of Bloom Caster

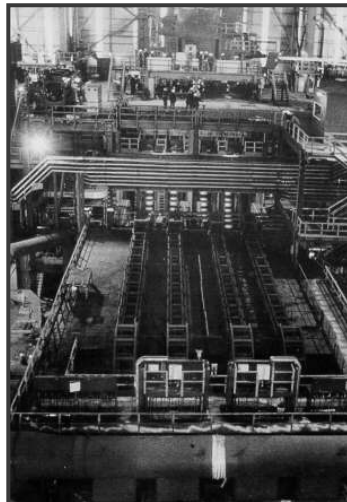

08/04/2008

4/20

Process schematic of an Industrial Bloom Caster

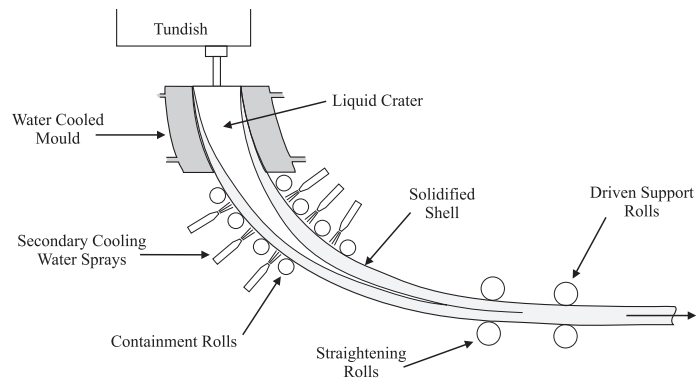

08/04/2008

5/20

Continuous caster. Typical bloom (left) and simplified diagram (right)

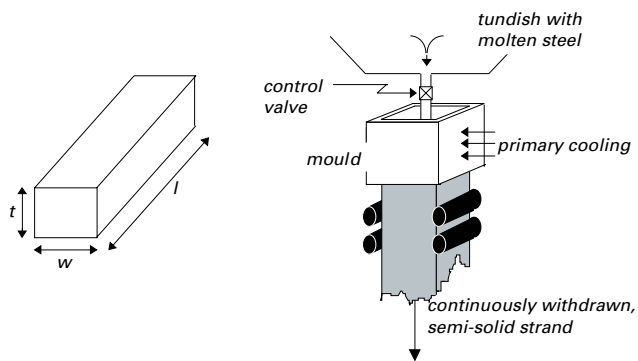

08/04/2008

6/20

Operators viewing the mould



08/

0

The cast strip in the secondary cooling chamber

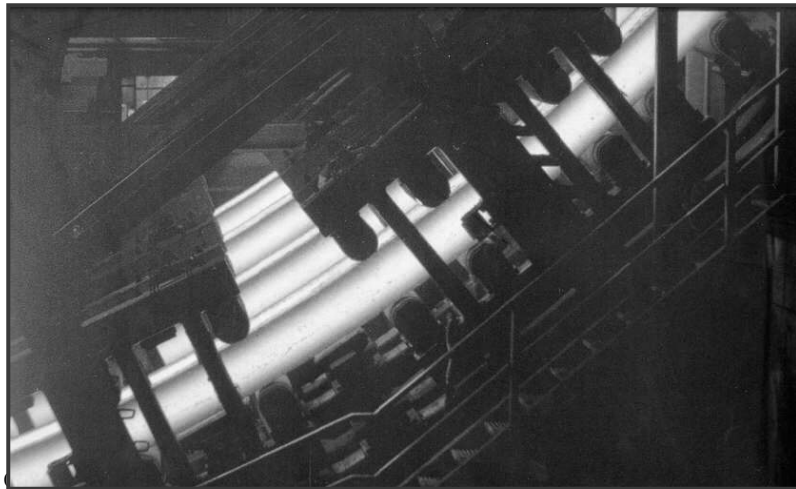

Performance specifications

The key performance goals for this problem are:

- y *Safety*: Clearly, the mould level must never be in danger of overflowing or emptying as either case would result in molten metal spilling with disastrous consequences.
- y *Profitability*: Aspects which contribute to this requirement include:
 - × Product quality
 - × Maintenance
 - × Throughput

08/04/2008

9/20

Modelling

To make progress on the control system design problem, it is first necessary to gain an understanding of how the process operates. This understanding is typically expressed in the form of a mathematical model.

h^* : commanded level of steel in mould

$h(t)$: actual level of steel in mould

$v(t)$: valve position

$\sigma(t)$: casting speed

$q_{in}(t)$: inflow of matter into the mould

08/04/2008 $q_{out}(t)$: outflow of matter from the mould

10/20

Model as simple tank

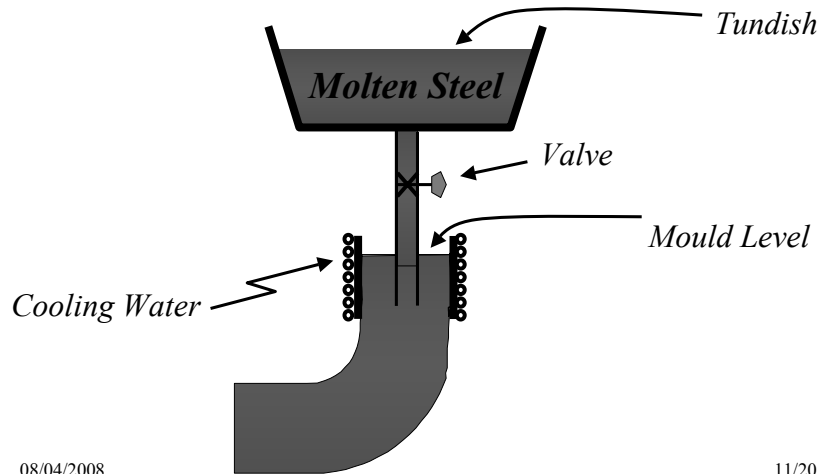

08/04/2008

11/20

Block diagram of the simplified mould level dynamics, sensors and actuators

These variables are related as shown below:

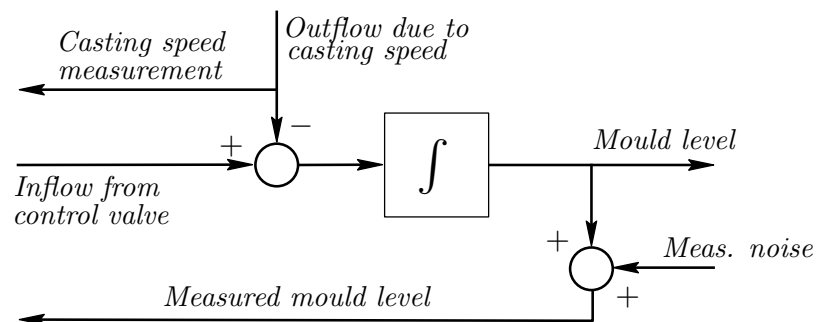

08/04/2008

12/20

Definition of the control problem

Abstracting from the above particular problem, we can introduce:

Definition 2.1:

The central problem in control is to find a technically feasible way to act on a given process so that the process behaves, as closely as possible, to some desired behaviour. Furthermore, this approximate behaviour should be achieved in the face of uncertainty of the process and in the presence of uncontrollable external disturbances acting on the process.

13/20

From open to closed loop architectures

Unfortunately, the open loop methodology will not lead to a satisfactory solution to the control problem unless:

- γ the model on which the design of the controller has been based is a very good representation of the plant,
- γ the model and its inverse are stable, and
- γ disturbances and initial conditions are negligible.

We are thus motivated to find an alternative solution to the problem which retains the key features but which does not suffer from the above drawbacks.

08/04/2008

14/20

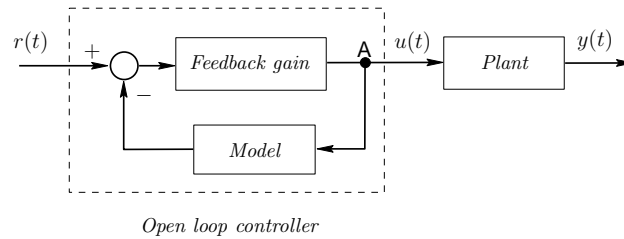
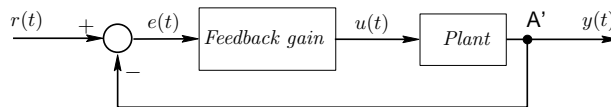
Figure 2.9: *Open loop controller*Figure 2.10: *Closed loop control*

08/04/2008

15/20

-
- y The first thing to note is that, provided the model represents the plant exactly, and that all signals are bounded (i.e. the loop is stable), then both schemes are equivalent, regarding the relation between $r(t)$ and $y(t)$. The key differences are due to disturbances and different initial conditions.
 - y In the open loop control scheme the controller incorporates feedback internally, i.e. a signal at point A is fed back.

08/04/2008

16/20

-
- In the closed loop scheme, the feedback signal depends on what is actually happening in the plant since the true plant output is used.

We will see later that this modified architecture has many advantages including:

- insensitivity to modelling errors;
- insensitivity to disturbances in the plant (*that are not reflected in the model*).

Figure 2.11: *Closed loop control with sensors*

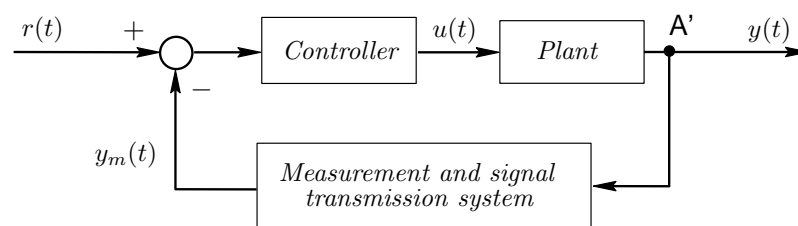

Desirable attributes of sensors

- y *Reliability*. It should operate within the necessary range.
- y *Accuracy*. For a variable with a constant value, the measurement should settle to the correct value.
- y *Responsiveness*. If the variable changes, the measurement should be able to follow the changes. Slow responding measurements can, not only affect the quality of control but can actually make the feedback loop unstable. Loop instability may arise even though the loop has been designed to be stable assuming an exact measurement of the process variable.

08/04/2008

19/20

Figure 2.12: *Typical feedback loop*

In summary, a typical feedback loop (including sensor issues) is shown below.

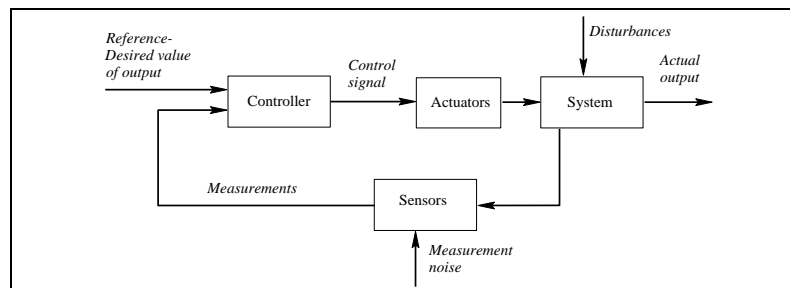

08/04/2008

20/20