Hybrid Control...

Continuous Time and Discrete Time Models

Motivation

In this lecture we will introduce the concept of *Hybrid Control*. By this terminology we mean the combination of a *digital* control law with a *continuous-time* system. We will be particularly interested in analysing the continuous response and the connections with the sampling points.

We recall the motivations and the main design concepts presented in the slides for the previous lectures.

The set-up for digital control of this system is shown schematically below:

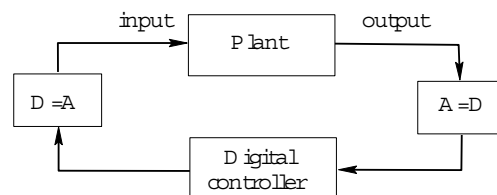

The objective is to cause the output shaft position, $y(t)$, to follow a given reference signal, $y^*(t)$.

Modelling

Since the control computations will be done inside the computer, it seems reasonable to first find a model relating the sampled output, $\{y(k\Delta); k = 0, 1, \dots\}$ to the sampled input signals generated by the computer, which we denote by $\{u(k\Delta), k = 0, 1, \dots\}$. (Here Δ is the sample period).

We saw in the previous lecture that the output at time $k\Delta$ can be modelled as a linear function of past outputs and past controls.

Thus the (*discrete time*) model for the controller takes the form:

$$y(\overline{k+1}\Delta) = \overline{a}_1 y(k\Delta) + \overline{a}_0 y(\overline{k-1}\Delta) + \overline{b}_1 u(k\Delta) + \overline{b}_0 u(\overline{k-1}\Delta).$$

A Modified Prototype Control Law

Now we want the output to go to the reference y^* .

Recall we have the model:

$$\begin{aligned} y(\overline{k+1}\Delta) &= \alpha_1 y(\overline{k-1}\Delta) + \alpha_2 y(\overline{k-2}\Delta) \\ &+ \beta_1 u(\overline{k}\Delta) + \beta_2 u(\overline{k-1}\Delta) + \beta_3 u(\overline{k-2}\Delta) \end{aligned}$$

This suggests that all we need do is set $y(\overline{k+1}\Delta)$ equal to the desired set-point $y^*(\overline{k+1}\Delta)$ and solve for $u(k\Delta)$. The answer is

$$u(k\Delta) = \frac{y^*(\bar{k}+1\Delta) - \alpha_1 y(\bar{k}-1\Delta) - \alpha_2 y(\bar{k}-2\Delta) - \beta_2 u(\bar{k}-\Delta) - \beta_3 u(\bar{k}-2\Delta)}{\beta_1}$$

Notice that the above control law expresses the current control $u(k\Delta)$ as a function of

- ◆ the reference, $y^*(\bar{k}+1\Delta)$
- ◆ past output measurements, $y(\bar{k}-1\Delta)$, $y(\bar{k}-2\Delta)$
- ◆ past control signals, $u(\bar{k}-1\Delta)$, $u(\bar{k}-2\Delta)$

Also notice that 1 sampling interval exists between the measurement of $y(\bar{k}-1\Delta)$ and the time needed to apply $u(k\Delta)$; i.e. we have specifically allowed time for the computation of $u(k\Delta)$ to be performed after $y(\bar{k}+1\Delta)$ is measured!

Recap

All of this is very plausible so far. We have obtained a simple *digital* control law which causes $y(k+1\Delta)$ to go to the desired value $y^*(k+1\Delta)$ in one step!

Of course, the real system evolves in continuous time (*readers may care to note this point for later consideration*).

We can note that that the continuous response could contain nasty surprises if certain digital controllers were implemented on continuous systems.

In the previous lectures we analysed and tried to explain:

- ❖ why the continuous response can appear very different from that predicted by the at-sample response
- ❖ how to avoid these difficulties in digital control.

Models for Hybrid Control Systems

A hybrid control loop containing both continuous and discrete time elements is shown in Figure 14.1.

We denote the discrete equivalent transfer function of the combination {zero order hold + Continuous Plant + Filter} as $[FG_0G_{h0}]_q$. We have

$$[FG_0G_{h0}]_q = \mathcal{Z} \text{ fsampled in pulse response of } F(s)G_0(s)G_{h0}(s)g$$

Figure 14.1: *Sampled data control loop. Block form*

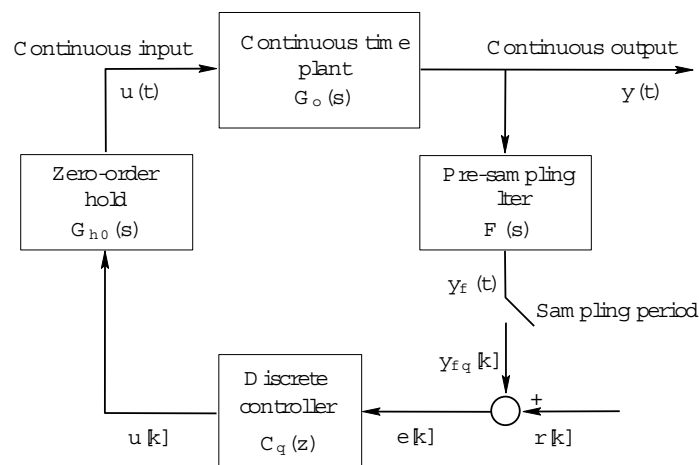

Design Remarks and Recalling (1)

27/05/2008

13/35

Continuous Time Controller Designs

Tools:

Bode Diagrams

Nichols Charts

Root Locus

Lag Network

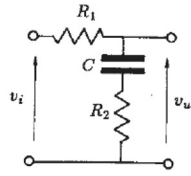

a)

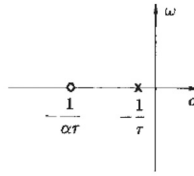

b)

$$G(s) = \frac{R_2 + \frac{1}{Cs}}{R_1 + R_2 + \frac{1}{Cs}} = \frac{1 + R_2 C s}{1 + (R_1 + R_2) C s} = \frac{1 + \alpha \tau s}{1 + \tau s}$$

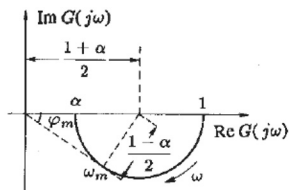

c)

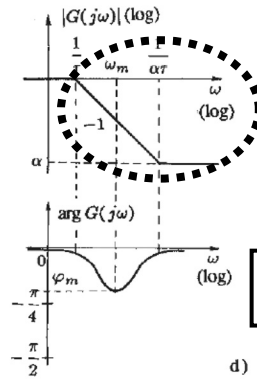

d)

$$\varphi_m = -\arcsen \frac{1 - \alpha}{1 + \alpha}, \quad \omega_m = \frac{1}{\tau \sqrt{\alpha}}$$

15/35

Lead Network

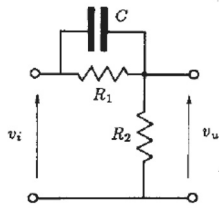

a)

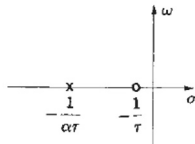

$$G(s) = \frac{R_2}{R_2 + \frac{1}{(1/R_1) + Cs}} = \frac{R_2 (1 + R_1 C s)}{R_1 + R_2 + R_1 R_2 C s} = \alpha \frac{1 + \tau s}{1 + \alpha \tau s}$$

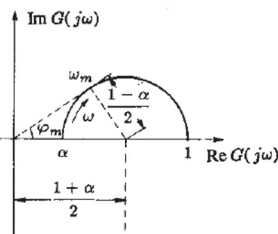

c)

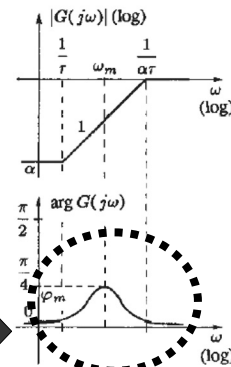

d)

$$\omega_m = \frac{1}{\tau \sqrt{\alpha}}$$

$$\varphi_m = \arcsen \frac{1 - \alpha}{1 + \alpha}$$

16/35

Proportional Controller

27/05/2008

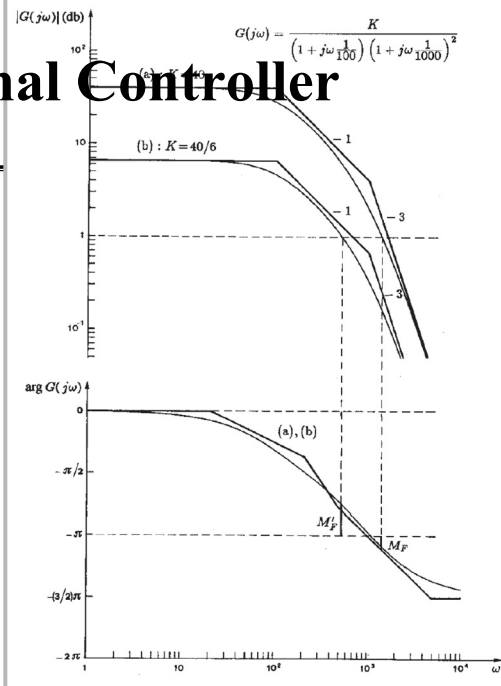

17/35

Lag Controller

27/05/2008

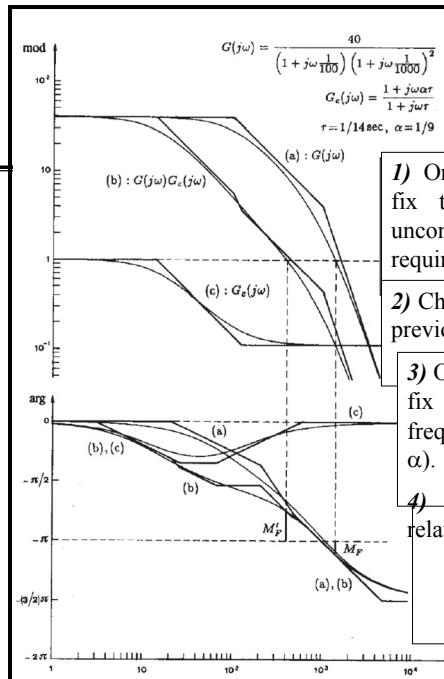

- 1) On the Bode phase diagram fix the frequency where the uncontrolled system has the required M_r .
- 2) Choose ω^* 20% less than the previous fixed frequency.
- 3) On the Bode magnitude plot fix the attenuation at the frequency ω^* (i.e. the value of α).
- 4) τ is computed by the relation:

$$\frac{1}{\alpha \tau} = \frac{\omega^*}{10}$$

18/35

Lead controller network

27/05/2008

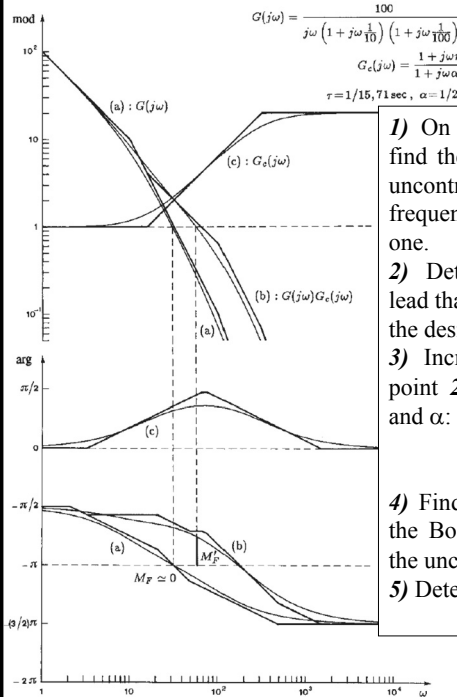

- 1) On the Bode phase diagram find the phase margin M_f of the uncontrolled system and the ω^* frequency where its magnitude is one.
 - 2) Determine the basic phase lead that is required for achieving the desired M_f .
 - 3) Increase the value fixed at point 2) and thus determine ϕ_m and α :
- $$\alpha = \frac{1 - \sin(\phi_m)}{1 + \sin(\phi_m)}$$
- 4) Find the frequency ω^* where the Bode magnitude diagram of the uncontrolled model is $\alpha/2$.
 - 5) Determine τ from the relation:

$$\omega^* = \frac{1}{\tau \sqrt{\alpha}} = \frac{19}{35}$$

Example: Root Locus

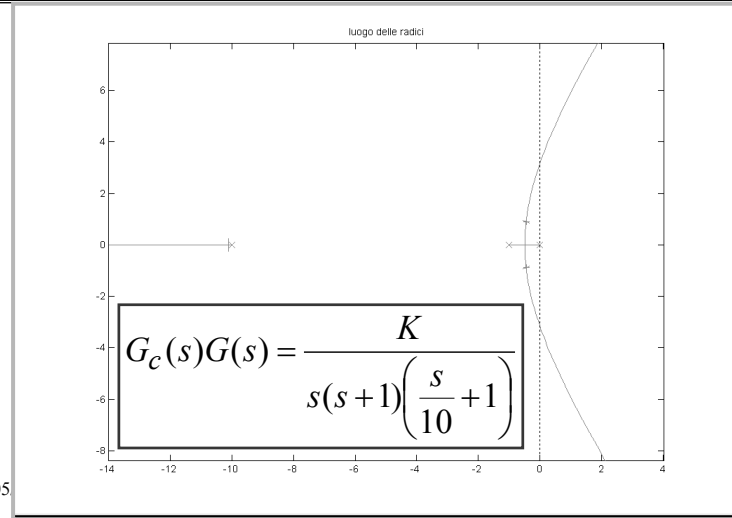
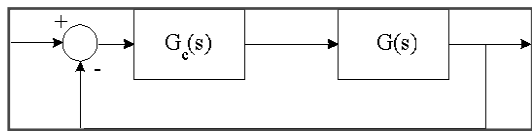

27/05

1/35

Root locus & δ -constant loci

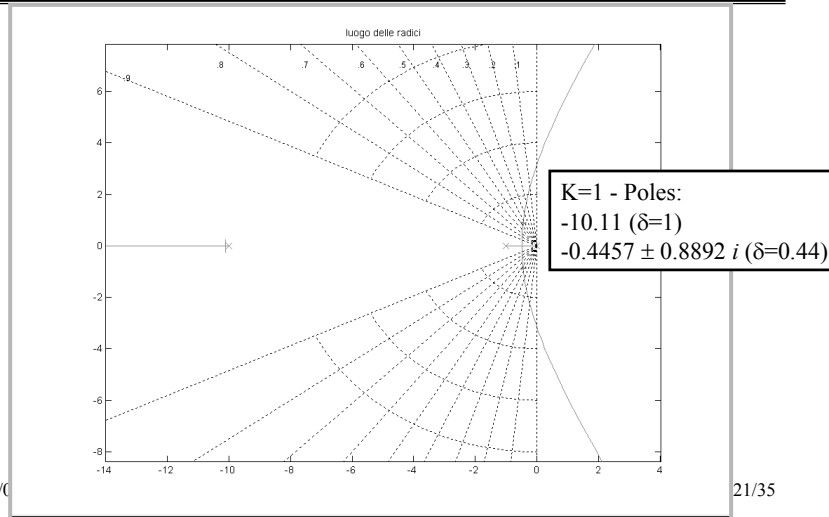

Step Response Example: Indices

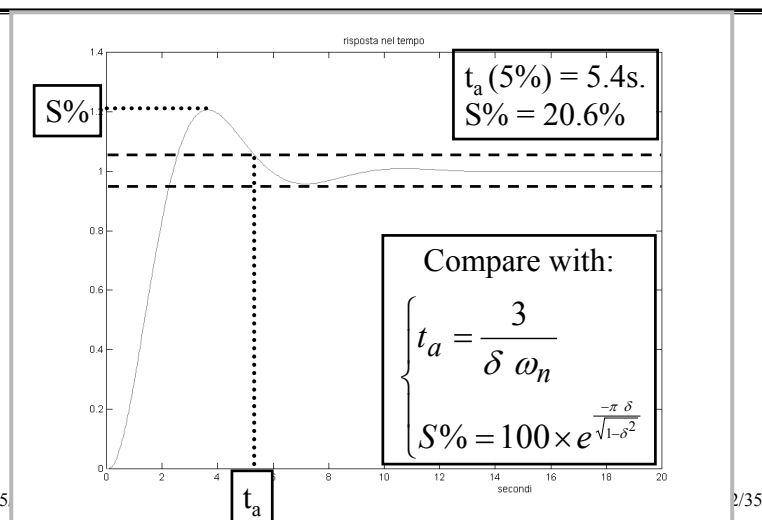
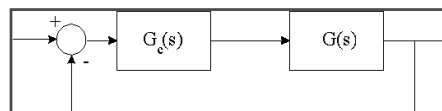

Design Remarks and Recalling (2)

Link between z and s planes (1)

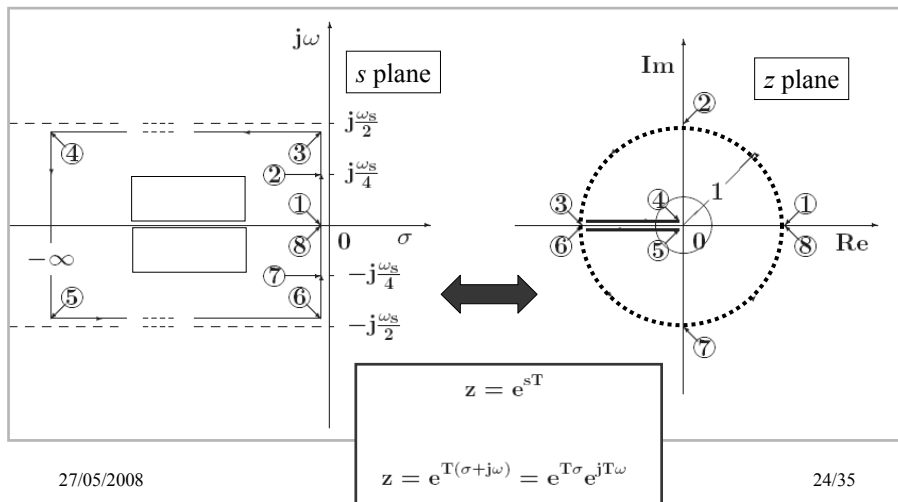

Link between z and s planes (2)

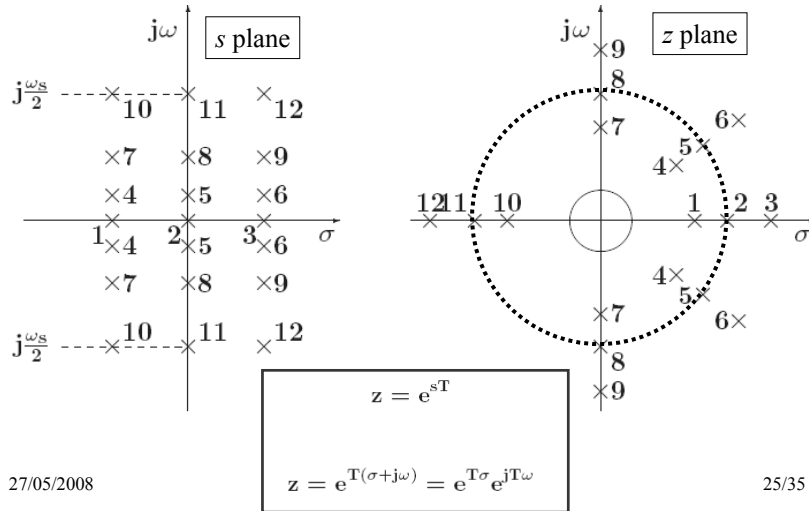

Discrete Model Stability

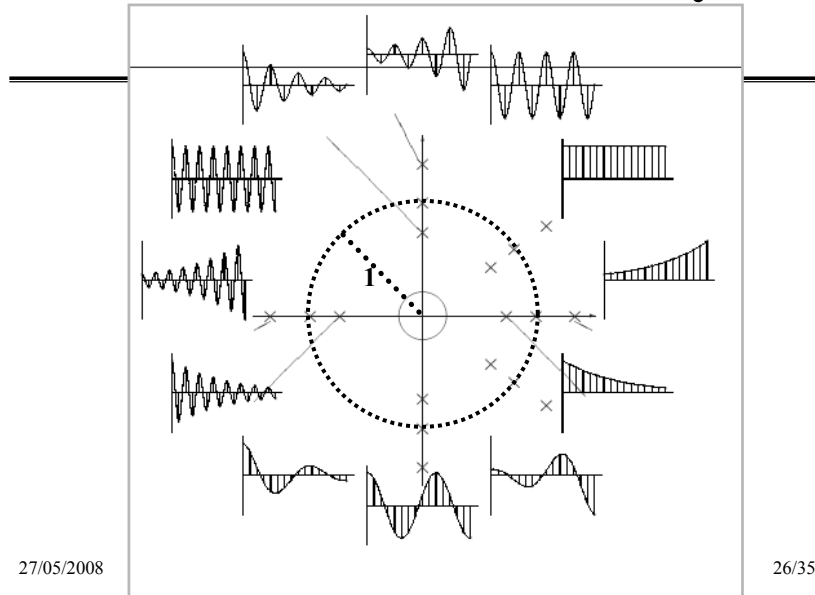

Design Strategy Overview

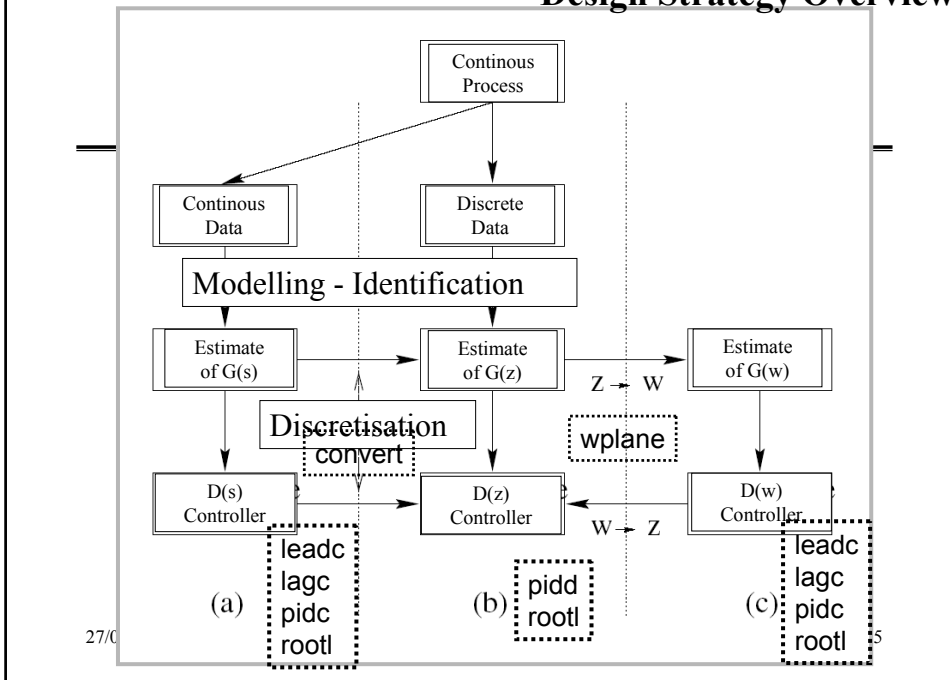

27/0

5

2nd order system Step Response (1)

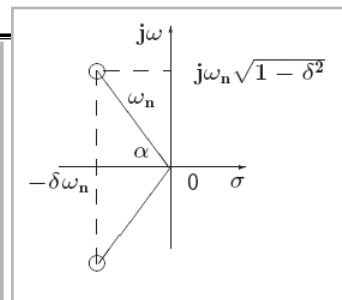
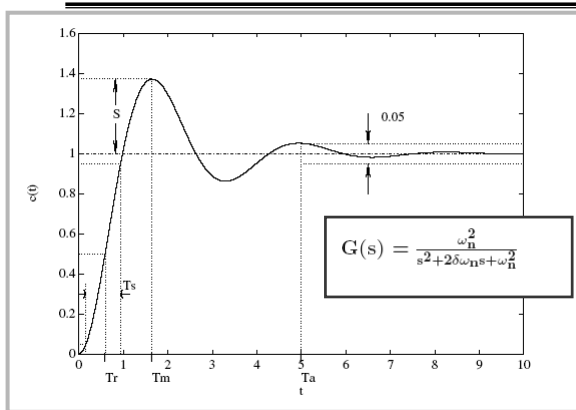

(1)
$$t_a = \frac{3}{\delta \omega_n}$$

Settling Time

2nd order system Step Response (2)

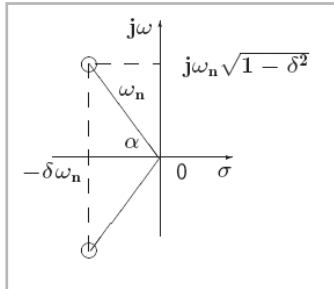

Overshoot

$$G(s) = \frac{\omega_n^2}{s^2 + 2\delta\omega_n s + \omega_n^2}$$

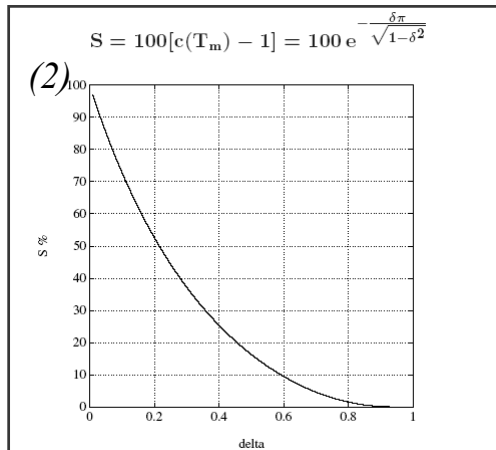

Plane s & Plane z Mapping

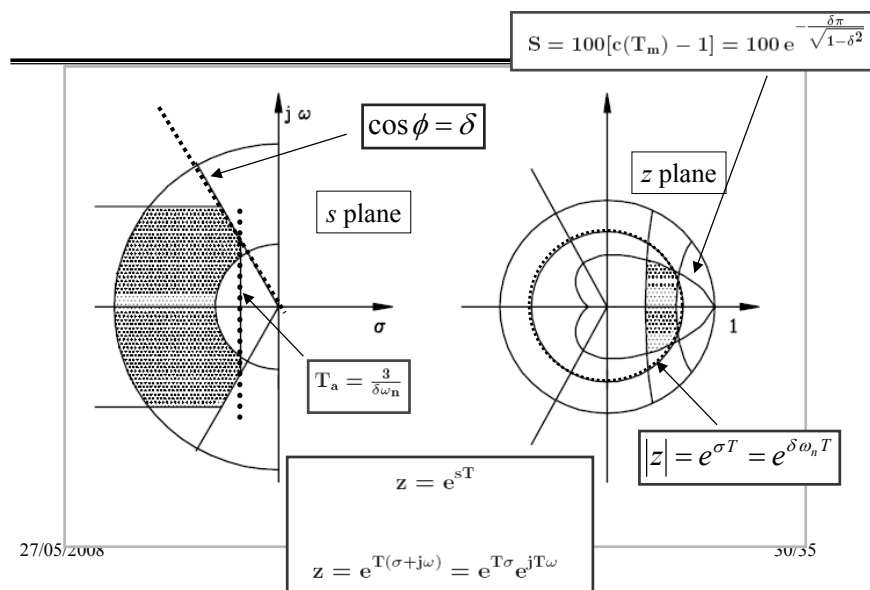

Frequency Response

z -plane \leftrightarrow w -plane

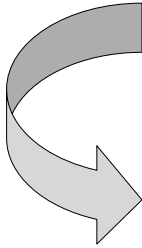

$$G(z) \quad z = e^{j\omega T} \rightarrow G(e^{j\omega T}).$$

(??? Non rational transfer function...)

$$w = \frac{2}{T} \frac{z - 1}{z + 1} \quad z = \frac{1 + w \frac{T}{2}}{1 - w \frac{T}{2}}$$

Recall:

$$z = e^{sT} \Big|_{s=j\omega} = e^{j\omega T} = \frac{e^{j\omega \frac{T}{2}}}{e^{-j\omega \frac{T}{2}}} = \frac{1 + j\omega \frac{T}{2}}{1 - j\omega \frac{T}{2}}$$

27/05/2008

31/35

Zero Order Hold Effects...

Figure 14.2: Connections between $y_f(t)$, $y_f[k]$ and $\hat{y}_f(t)$ for $y_f(t) = \sin(2\pi t)$, $\Delta=0.1$

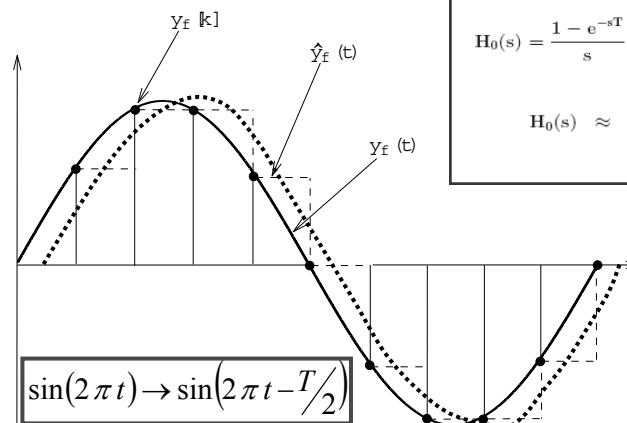

$$H_0(s) = \frac{1 - e^{-sT}}{s} \approx \frac{T}{\frac{T}{2}s + 1}$$

$$H_0(s) \approx e^{-sT/2}$$

27/05/2008

32/35

Phase Margin Degradation!

$$H_0(s) = \frac{1 - e^{-sT}}{s} \approx \frac{T}{\frac{T}{2}s + 1}$$

$$H_0(s) \approx e^{-sT/2}$$

$$M_f^{(h0)} \cong M_f - T/2 \quad !!!$$

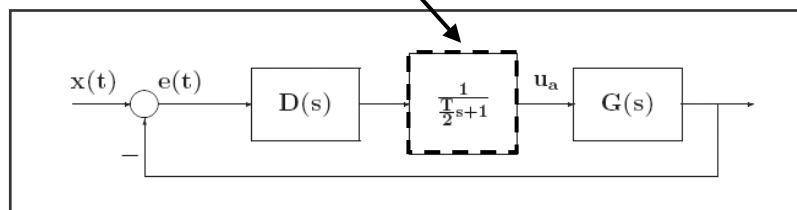

27/05/2008

33/35

Discretisation Techniques...

$$D(z) = D(s) \Big|_{s=\frac{z-1}{T}} \quad \text{Euler forward)$$

$$D(z) = D(s) \Big|_{s=\frac{1-z^{-1}}{T} = \frac{z-1}{Tz}} \quad \text{Euler (backward)}$$

$$D(z) = \mathcal{Z} \left[\mathcal{L}^{-1} [D(s)] \right]$$

Sampled Impulse Response Discretisation

$$D(z) = (1 - z^{-1}) \mathcal{Z} \left[\frac{D(s)}{s} \right] = \mathcal{Z} \left[\frac{1 - e^{-sT}}{s} D(s) \right]$$

27/05/2008

Hold Equivalence

34/35

Summary

- ❖ Hybrid analysis allows one to mix continuous and discrete time systems properly.
- ❖ Hybrid analysis should always be utilized when design specifications are particularly stringent and one is trying to push the limits of the fundamentally achievable.